

Standard pipe clamp

Standard pipe clamp is type of pipe hanger that clamps around a pipe to connect the pipe to the remainder of the pipe hanger assembly. It is normally used in conjunction with eye rod to allow flexibility at the rod attachment.

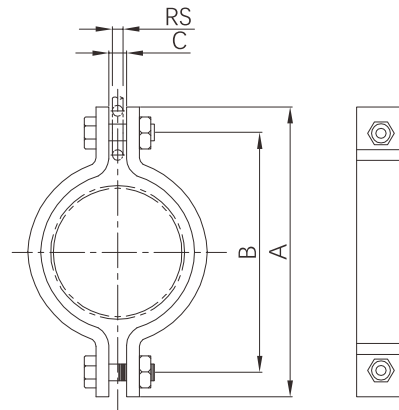

- Certificate: UL Listed / FM Approved
- Standard: UL 203, MSS SP-58/69 (Type-4)
- Material: Carbon steel
- Surface: Pre-galvanized / electro-galvanized
- Application: Non-insulated stationary pipeline



Available size

Pipe size		Hanger Rod Size (RS)		Dimension (mm)			Max recommend load (N)	Ref. No.
NPS	DN	UNC	Metric	A	B	C		
1/2"	15	3/8"	M10	86	56	12	2220	P4401 (UL)
3/4"	20	3/8"	M10	95	65	12	2220	P4402 (UL/FM)
1"	25	3/8"	M10	100	70	12	2220	P4403 (UL/FM)
1-1/4"	32	3/8"	M10	110	80	12	2220	P4404 (UL/FM)
1-1/2"	40	3/8"	M10	120	90	12	2220	P4405 (UL/FM)
2"	50	1/2"	M12	140	105	12	2220	P4406 (UL/FM)
2-1/2"	65	1/2"	M12	170	135	12	2220	P4407 (UL/FM)
3"	80	1/2"	M12	180	145	12	2220	P4408 (UL/FM)
4"	100	1/2"	M12	215	180	16	4400	P4409 (UL/FM)
5"	125	1/2"	M12	250	210	16	4400	P4410 (UL/FM)
6"	150	1/2"	M12	290	250	18	5544	P4411 (UL/FM)
8"	200	5/8"	M16	350	305	18	5544	P4412 (UL/FM)
10"	250	5/8"	M16	435	365	18	5544	P4413 (FM)
12"	300	5/8"	M16	485	415	18	5544	P4414 (FM)